

Specifications/技术参数:

Electrical/电气特性:

Current Rating (额定电流): 1A
 Withstand Voltage (耐压值): 500VAC for one minute
 Contact Resistance (接触电阻): 20mΩ max
 Insulation Resistance (绝缘电阻): 1000MΩ min
 Operating Temperature (工作温度): -40°C ~ +105°C

Physical/物理特性:

Insulator (塑胶本体): P.B.T or PA6T +30% GF, Color Black
 Flammability Rating (防火等级): UL 94V-0
 Contacts (接触件): Brass
 Contacts plating (接触件电镀): Gold flash over Nickel

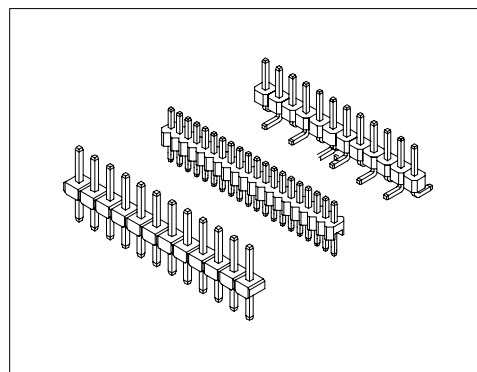

Dimension/尺寸: mm

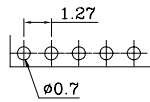
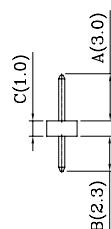
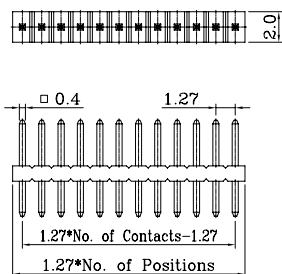

PCB LAYOUT
线路板布局图

Single row 04 to 50 contacts/单排4-50芯
 0.4mm Square post/0.4mm四方针
 Base height/塑体高度: 1.0mm standard

Ordering Code/订购型号:
 201-1S-1*nPG-3.0/1.0/2.3

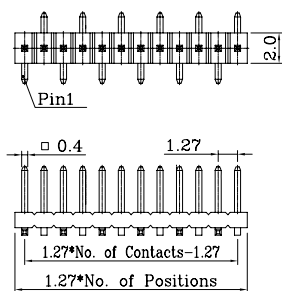

Type-A

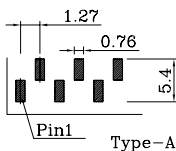
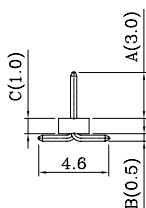

Type-A

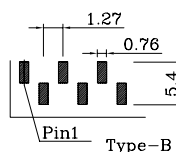

Type-B

PCB Layout
线路板布局图

Single row 04 to 50 contacts/单排4-50芯
 0.4mm Square post/0.4mm四方针
 Base height/塑体高度: 1.0mm standard

Ordering Code/订购型号:
 201-1SMS-1*nPG-3.0/1.0/0.5-A

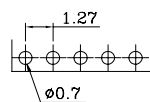
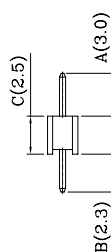
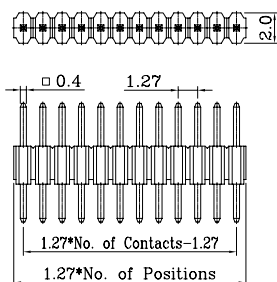

PCB LAYOUT
线路板布局图

Single row 04 to 50 contacts/单排4-50芯
 0.4mm Square post/0.4mm四方针
 Base height/塑体高度: 2.5mm standard

Ordering Code/订购型号:
 201-1S-1*nPG-3.0/2.5/2.3

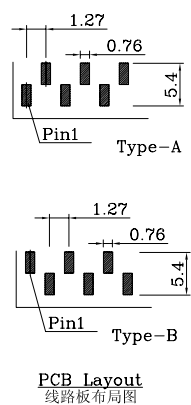
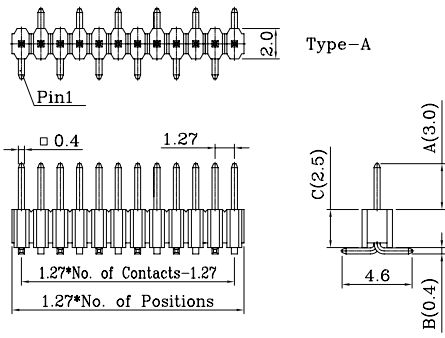

Single row 04 to 50 contacts/单排4-50芯
 0.4mm Square post/0.4mm四方针
 Base height/塑体高度: 2.5mm standard
 Ordering Code/订购型号:
 201-1SMS-1*nPG-3.0/2.5/0.4-A

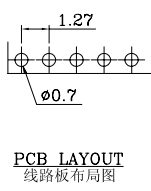
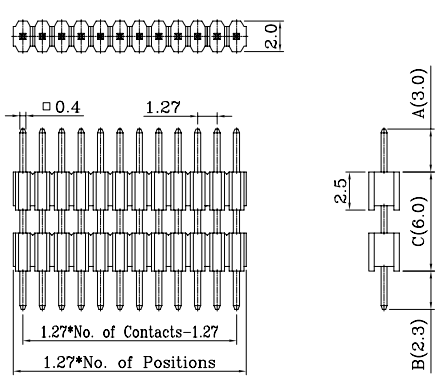

Single row 04 to 50 contacts/单排4-50芯
 0.4mm Square post/0.4mm四方针
 Base height/塑体高度: 2.5mm standard
 Ordering Code/订购型号:
 201-1DLS-1*nPG-3.0/6.0/2.3

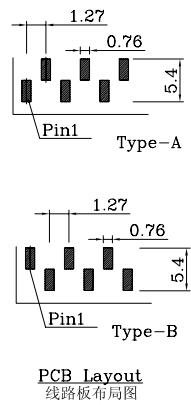
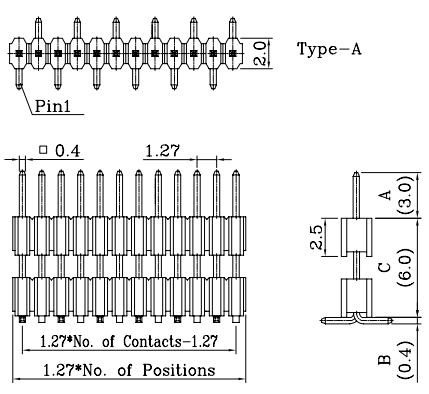

Single row 04 to 50 contacts/单排4-50芯
 0.4mm Square post/0.4mm四方针
 Base height/塑体高度: 2.5mm standard
 Ordering Code/订购型号:
 201-1DLSMS-1*nPG-3.0/6.0/0.4-A

Ordering Code/订购型号:

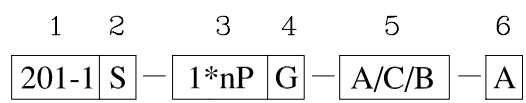

- | | | |
|--|--|---|
| <p>1. Series No./系列号:
201-1</p> <p>2. PCB Mount Type/安装类型:
 S = Vertical DIP Type(直插)
 SMS = Vertical SMT Type(立贴)
 DLS = Dual Bodies Vertical DIP(双塑体直插)
 DLSMS = Dual Bodies Vertical SMT(双塑体立贴)</p> | <p>3. Poles/位数:
1*4P ~ 1*50P</p> <p>4. Contacts plating/接触件电镀:
 S = Selective Gold(半金)
 G = Gold flash(全金)
 G3 = 3μ" Gold(镀金3μ")</p> | <p>5. Pin Dimension/方针尺寸:
A/C/B</p> <p>6. Options/选项:
 A = Type-A (正脚位)
 B = Type-B (反脚位)</p> |
|--|--|---|